

# Operating, cleaning and maintenance guide



For alternative formats visit the Residents' Zone  
[www.anglian-building.co.uk](http://www.anglian-building.co.uk)



# Contents

<b>Introduction</b>	<b>3</b>	<b>Cleaning and maintenance</b>	<b>18</b>
<b>Opening and closing windows</b>	<b>4</b>	PVCu window and door frames	18-19
Outward-opening casement windows	4	Outward-opening casement windows	20
Tilt and turn windows	5	Fire-egress hinges	20
Vertical sliding windows	6-7	Vertical sliding windows	21
Secondary double glazing	8	Horizontal sliders	22
Fully reversible casement window	9	Side hinged	23
		Lift out (fixed pane windows)	23
		Vertical sliders	24
<b>Opening and closing doors</b>	<b>10</b>	<b>Lubrication</b>	<b>25</b>
Single doors (PVCu and composite)		Casement windows	25
- unlocking	10	Tilt and turn windows	26-27
- locking	11	Door lubrication	28-29
Double doors		<b>Adjustments</b>	<b>30</b>
- unlocking	12	Outward-opening casement window	30
- locking	13	Tilt and turn windows	30-31
Sliding patio doors (PVCu)	14	Door adjustment	31
		<b>Condensation</b>	<b>32-33</b>
<b>Hinges and restrictors</b>	<b>15</b>	<b>Troubleshooting</b>	<b>34</b>
Restrictor hinges	15	Outward-opening casement windows	35-36
Spring hook and peg restrictors	15	Tilt and turn windows	37
Surface-mounted restrictor	15	Doors	38-39
Fire-escape and easy-clean hinges	15		
<b>Ventilation and safety chains</b>	<b>16</b>		
Trickle vents	16		
Over-glass vents	16		
Vent-trek fan	16		
Corded vents	16		
Night ventilation position	17		
Safety chains	17		

# Introduction



This booklet provides you with instructions on how to operate, clean and maintain Anglian products, to help you make sure they last as long as possible.

Failure to carry out regular cleaning and maintenance in line with these instructions may mean the guarantee is not valid.

During their lifetime, your products may need minor adjustments to compensate for normal wear and tear.

Please see the sections on adjustments on page 30.

If you think you may have a problem with your windows or doors, before calling us, read the troubleshooting section within the guide. There may be a quick and easy way to fix your problem.

# Opening and closing windows

## Outward-opening casement windows

There are two types of handle - locking and non-locking.



### Locking handle

If the window is locked, unlock it using the key provided. Remove the key. Push the button on the handle and turn the handle 90°. Then push the window to the position you want.



To close, pull the window closed and turn the handle 90° back to its original position. Relock the window and remove the key for security and child safety.

### Non-locking handle

Push the button on the handle and turn the handle 90°. Then push the window to the position you want.

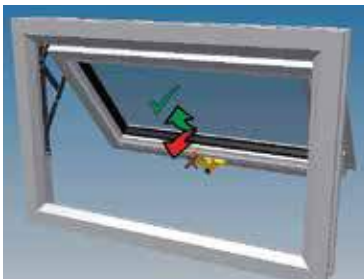

### Top-hung window

When closing top-hung windows, take care not to twist the handle downward as you pull the window to close it.



### Flying mullion casement

Flying mullion casements operate in the same way as a single window casement. It is only the opening sequence that makes them different. The main (primary) window needs to open first and close last to prevent the windows from clashing.

## Tilt and turn windows

Tilt and turn windows can have two opening positions.



**Tilt** – Leaning in at the top to allow controlled ventilation.



**Turn** – Opening inward for cleaning and greater access.

### Locking and unlocking

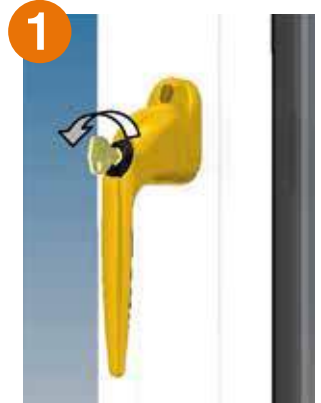

Lock and unlock the window with the key provided.

### Tilt position



Press the button and turn the handle 90°, pull the window towards you into the tilt position.



If you have the optional variable tilt device fitted, when tilted, further turn the handle to place the window in the tilt position you want.

### Turn position



To close the window, press the button and turn the handle a further 90°. Gently pull the window open into the turn position.

# Opening and closing windows

## Vertical sliding windows



Unlock the catches with the key provided and turn the lever 180°.



You can then slide the windows open for ventilation by pushing the bottom window up or pulling the top window down.

Some windows are fitted with spring-loaded child restrictors, which limit how far the window can open to approximately 100mm. They can be locked in the open or closed position.



Unrestricted closed position - turn the key anticlockwise to unlock.



Restricted open position - turn the key clockwise to unlock and limit how far the window can open to 100mm.



Limited window opening.



Spring-loaded restrictor shown limiting how far the window can be opened. Press and slide window to open position.

# Opening and closing windows

## Secondary double glazing

### Horizontal slider

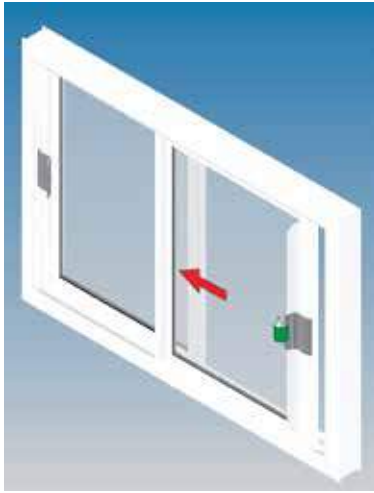

Undo the handle and slide the window away from the frame to the position you want.

### Vertical slider

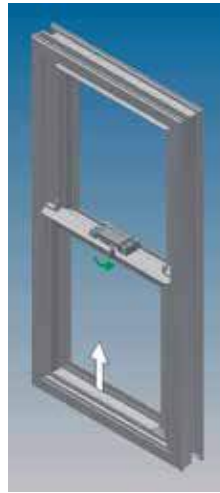

Undo the latch and slide the window upwards to the position you want.

### Side hinged



Undo the latch to unlock the window.



Once the window has been unlocked, the window will swing open. There is no fixed position when open.



## Fully reversible casement window

Fully reversible windows open in the same way as shown for casement windows on page 4.



The window has an automatic safety restrictor which restricts the initial opening to about 100mm (until it is released).



The safety restrictor, on the left-hand side of the window, is released by pushing the button marked 'PRESS' until it passes the two stops in the aluminium channel.



The fully reversible window can turn 180° to allow it to be cleaned easily from inside. Pull down the casement top rail with both hands. The automatic restrictor acts as a reverse restrictor in two positions, allowing the window to be cleaned safely.

To return the window after it has been cleaned, push the button marked 'PRESS' as before and lift the casement top rail.

To close the window, push the button marked 'PRESS' and pull the window closed and follow instructions on page 4.

# Opening and closing doors

## Single doors (PVCu and composite) – unlocking



Door is closed and locked.

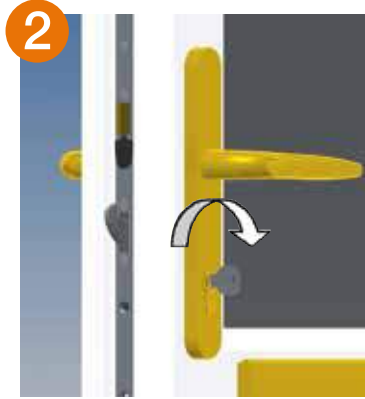

Turn the key or thumb turn one full turn away from the lock edge to unlock the deadlock.



Push the handle down to retract the hook bolts and the latch. This allows the door to be opened.



Some front-door fittings need a turn of the key to retract the latch bolt from outside. Turn the key away from the lock edge to retract the latch bolt.

**Note:** Some doors have a handle type that means to open the door from the outside you must always use a key. **Please ensure you take the key with you otherwise you will not be able to get back in.**

**Note:** The door must be fully locked to be secure, not just shut or held on the latch.

**Note:** It is important that you never leave your key in the lock on the inside to prevent the risk of being locked out of the property.

## Single doors (PVCu and composite) – locking

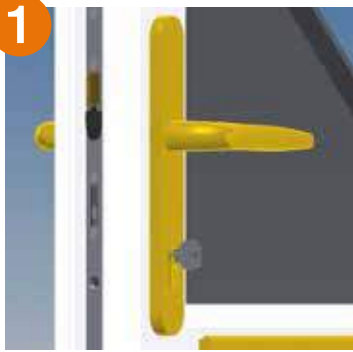

Close the unlocked door.

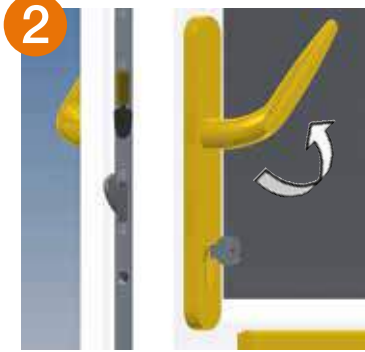

Lift the handle upwards as far as it will go. This engages all hook bolts.

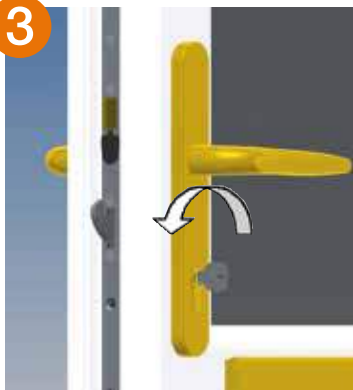

Turn the key or thumb turn one full turn towards the lock edge to deadlock all hook bolts and the latch bolt.

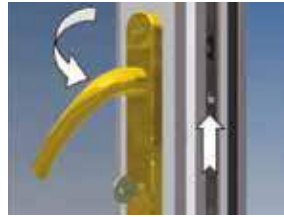

### Operating the snib

A snib is available on some doors. It is possible to keep the latch pulled back so the door can open from the outside without the key. Push the handle on the inside down to retract the latch and slide the white button (snib located in the faceplate) upwards.



**Unless you complete step 3, your door is not fully secure.**



**While the snib is in use, your door is not secure.**

### Thumb-turn cylinders

Some doors may be fitted with a thumb-turn knob to the inside of the door. The door will lock and unlock as usual with the key from the outside. The inside knob replaces the need for a key from the inside. Turn the knob through one full turn to either lock or unlock.



**Please make sure that whenever the door is shut, the handle is lifted up. This fully engages the multipoint locking system into the frame, and will help the door to keep its shape.**

# Opening and closing doors

## Double doors – unlocking

Double doors open and shut in a similar way to a single door. It is only the opening sequence that makes them different in that the main door needs to open first and close last to prevent them clashing.

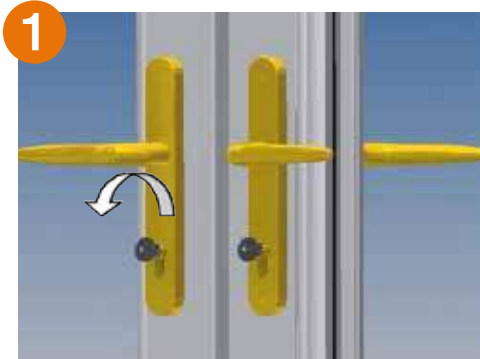

Turn the key one full turn away from the lock edge to unlock the latch and hook bolts.



Push the handle down to pull back the latch and hook bolt. This allows the door to be opened.



To open the secondary door, simply push the handle down to unlock the top and bottom shootbolts and turn the key one full turn away from the lock edge.

## Double doors – locking

Double doors open and shut in a similar way to a single door. The difference is that the main door cannot be locked without the secondary door shootbolts also being locked.



Close the secondary door, lift the handle to lock the shootbolts into their keeps and lock by turning the key one full turn towards the lock.



Close the main door and lift the handle to lock both shootbolts and hook locks.



Turning the key one full turn towards the lock engages the deadlock.



**Unless step 3 is done your door is not fully secure.**

**Note:** It is important that you never leave the key in the lock to prevent the risk of being locked out of the property.

# Opening and closing doors

## Sliding patio doors (PVCu)

Sliding doors have two locking mechanisms - either one or two plunger locks to the central meeting stiles to lock the panes together and a four point lock jamb at the side of the frame.



### Plunger lock

Begin by unlocking the plunger locks. To unlock the centre plunger lock, turn the key until the plunger retracts.



To lock, once the sliding door is closed, simply push the plunger closed.

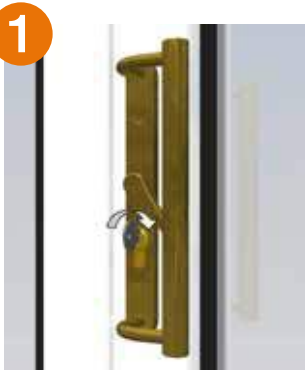

### Jamb lock

Turn the key one full turn away from the lock edge to unlock.



Lift the lever fully to unlock the lock bolts from the jamb. Locking is simply the reverse action.

# Hinges and restrictors

Hinges are fitted as standard on our casement windows.



## Restrictor hinges

These may be released by pressing the buttons within the hinge. A top-opening window will have a button to press on either side of the window. Side-opening windows will have a button at the bottom only.



## Spring hook and peg restrictors

These are often fitted to fire-escape windows and released by pushing the hook to the side and away from the peg.



## Surface-mounted restrictor

This can be unlocked using an Allen key and opened by pressing the button while opening the window.



## Fire-escape and easy-clean hinges

These are fitted to selected windows allowing them to open fully. To operate the easy-clean facility, press buttons both top and bottom and slide the window along. To close the window, press the buttons and pull the window to the closed position.

# Ventilation and safety chains

The use of vents allows fresh air to enter the home and helps reduce condensation.



## Trickle vents

Trickle vents are at the top of the window. To open, slide the vent to the centre of the window.

To close, slide the vent back in the opposite direction.

Once opened, the vents can be angled up or down to get rid of draughts.



## Vent-trex fan

These are sometimes fitted in bathrooms and kitchens. The unit can be used in two ways, as an extractor fan or as a trickle vent.

For ventilation, slide the button on the underneath of the unit to open to allow air in. To operate the fan, slide the button on the underneath of the unit and pull the cord, a light will come on. To change the fan speed, pull the cord twice quickly. Pull the cord once to turn the fan off and the light will go out.



## Over-glass vents

The vent is operated by pushing the catch up to open or down to close. To close the vent, push the plastic catch upwards at either end of the vent.

On longer glass vents, both ends of the vent shut may need to be clicked shut.

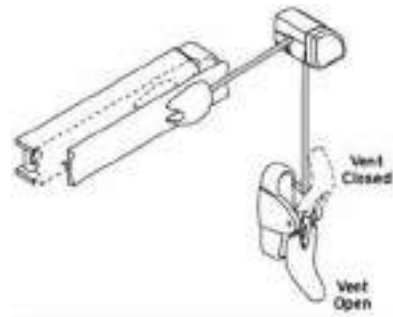

## Corded vents

Some trickle vents may be fitted with cord controls to make them easy to use.

They will be either loose cords – which will need one cord pulled to open and the other cord pulled to close or fitted with a lever to the lower section of the window.

When the lever is in the 'up' position the vent is closed. When the lever is in the 'down' position, the vent is open.



### Night ventilation position

Some outward-opening casement windows can be locked in a partially closed position to provide ventilation.

Turn the handle 90° to open the window and push it open slightly, leaving a gap for ventilation. Turn the handle down 90° to the closed position to engage the metal locking mechanism within the window frame.



**Windows are not secure when in this position.**



### Safety chain



#### To use the safety chain

Find the flat metal plate section of the chain and push it through the gap of the plate attached to the door.



#### To take the safety chain off

The flat metal plate section of the chain is passed through the plate.

# Cleaning and maintenance

Regular, careful cleaning of your Anglian products is needed to prevent the build-up of everyday grime and atmospheric pollutants and help prolong their life.

## PVCu window and door frames

✓ Please clean your frames with plenty of clean, warm soapy water (washing up liquid is suitable), and wipe dry with a clean, soft cloth. The need for cleaning will vary depending on where your windows are and environmental conditions in your area. In general, we recommend that your windows and doors are cleaned at least once every three months.

✓ Please always make sure that the drainage slots (shown below) are kept unblocked and free from dirt, grit, spiders' webs and so on. This will allow any water that appears in the frame to drain away and prevent any leaks.

✓ Please be careful when cleaning PVCu products with decorative finishes such as dark woodgrain, golden oak, white foil, anthracite grey and dual products to avoid damage to the decorative surface.



✓ Please keep the small gap between your sill and window or door on the outside clear of any dirt to allow for drainage (shown below).



✓ Please keep casement window hinges, vertical slider and sliding-door tracks clear of dust and debris to reduce wear on sliding parts.

✗ Please do not use abrasive cleaners or scouring pads.

✗ Please do not use any type of harsh cleaning agents such as bleach, solvents (for example, white spirits, cellulose thinners, nail varnish remover), aerosol products such as WD40®, automotive dashboard wipes, acids, brick wash solutions or alkalis.

✗ Please do not use too much pressure when cleaning, for example, pressure washers.

✗ Please do not paint.

### Glass

✓ Please clean the glass regularly using clean, warm soapy water or glass cleaner. If using glass cleaner, apply it to the cloth to avoid getting excess glass cleaner on the frames. You can use both warm soapy water and glass cleaner on lead effects.

# Cleaning and maintenance



**Caution.** Take care to avoid any risk of falling from an open window.

## Outward-opening casement windows

The outward-opening casement window hinges open to allow access to clean the outside of your windows (as shown right).



## Fire-egress hinges

For windows that need easy access in case of fire, the hinges open in a way to give the maximum opening but prevent the ability to clean the window from this position. These windows can be easily moved along the hinge track to allow for cleaning outside.

1



Open the window until it is fully open.

2



Press down the button on the bottom hinge and move the window slightly to the handle side to release the hinge. Repeat the process for the top hinge.

3



Now the window is free to slide along the track to allow for easy access to clean the windows.



**Caution.** Take care not to trap fingers in the mechanism.

To close the window, just pull the window handle inwards and the hinge will automatically return to its original position.

## Vertical sliding windows

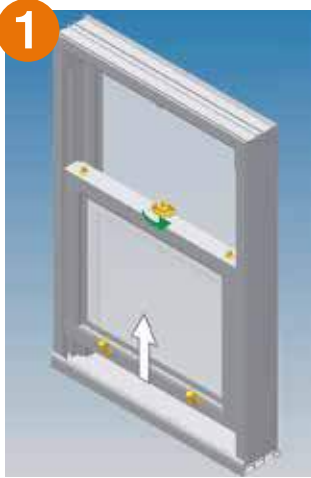

To open, raise the bottom sash by at least 75mm off the sill.



Push both retaining clips inwards towards the centre of the window. This will allow the sash to be tilted.



Gently pull the bottom sash to tilt into the room until it stops, resting on the side arms. You can clean the outside glass in this position. The sash cannot be moved up or down while in the tilted position.



Slide the top sash down to about 75mm above the bottom sash and repeat the previous steps.



Lower the top sash very carefully until it rests on the side arms. You can then clean the top sash outside glass.



To close, tilt sashes one at a time to the upright position and push firmly until the spring catches engage in the outer frame.

# Cleaning and maintenance

## Secondary double glazing



Caution. Glazed sashes can be heavy.

### Horizontal sliders

These windows can be lifted out for easy access to clean both the secondary double glazing and the window behind it.

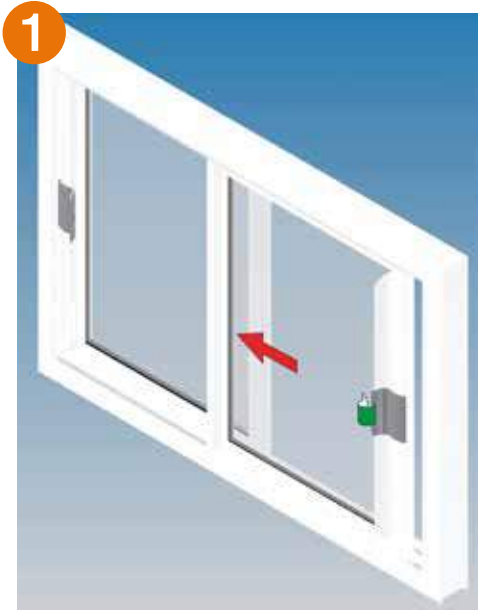

Undo the handle and slide the window away from the frame.



Lift the window up and gently pull the bottom of the window clear of the frame.

Repeat this process for each window. To replace the windows, lift the glazing back into the frame.



**Caution. Glass can be heavy.**

### Side hinged

To clean the windows, please follow the operating instructions on page 8.

### Lift out (fixed-pane windows)

These windows can be lifted out for easy access to clean both the secondary double glazing and the window behind it.



Lift up the window and gently pull the bottom of the window clear of the frame.



Completely remove the window for easy access to clean.

**Please note:** that fixed units do not have a cleaning position.

# Cleaning and maintenance

## Vertical sliders

This type of window can be tilted inwards to allow you to clean the outside surface.

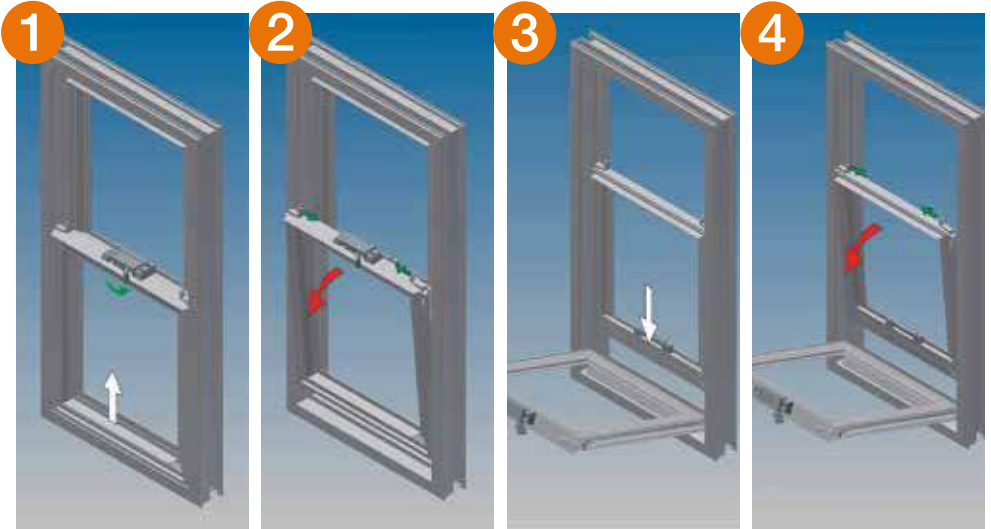

1 Raise the bottom window by at least 75mm off the sill.

2 Slide the catches on top of the window towards the centre of the window, which will allow the window to tilt.

3 Gently pull the top of the window inwards and then rest it on a suitable support. Please note that windows cannot be left unsupported in the cleaning position.

4 With the bottom window supported, the top window can now be lowered to within 75mm of the bottom window. Repeat the previous steps to tilt the top window. This time the top window can be rested on the bottom window.

5 To close, tilt the top window and return it to the upright position, push firmly until the spring catches engage into the outer frame. Repeat for the bottom window.



# Lubrication

## Window lubrication – all materials

You need to regularly lubricate the moving parts to keep the windows operating properly. You should carry out the following lubrication and maintenance checks once a year.

✓ Please use a general light engineering oil with corrosion inhibitors such as 3-in-one® Multi Purpose Oil (available in aerosol can for convenience).

✗ Please do not use solvent-based aerosol sprays such as WD40®. These contain chemicals that attack parts of the window. This can result in weakening and breaking parts of the window and may stop them working. They will also damage decorative finishes.

### Casement windows – hinges



Lubricate all pivot points with oil and wipe away the excess.

### Casement windows – locks

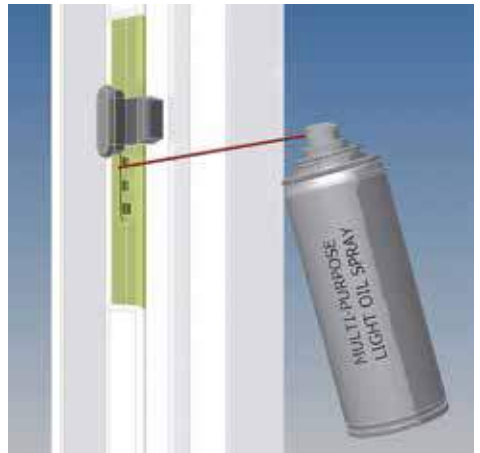

Lubricate all moving parts in the window to help them to operate easily.

# Lubrication

## Tilt and turn windows

The diagram below shows the exact points that need lubricating every year.

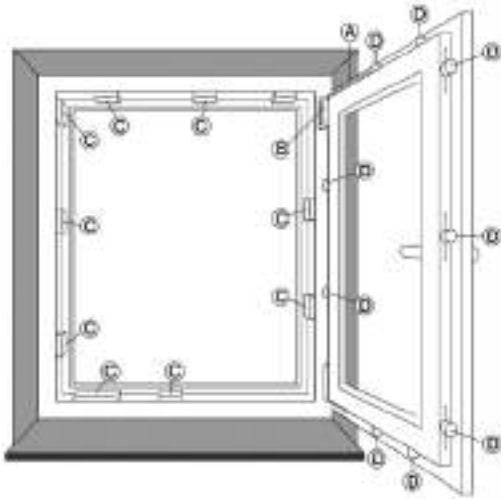

- A Top arm (the shear)
- B Top hinge (shear hinge)
- C Keep
- D Roller

### A Top arm (the shear)



The top arm must be oiled at all pivot points. Spray a small amount of oil on the points shown above.

### B Top hinge



These are only fitted to tilt and turn windows that open to 180°. The top hinge (above left) must be oiled at all pivot points.

Spray a small amount of oil on the points shown. Remove the plastic cover if fitted, and spray a small amount of oil onto the top of the hinge (above right).

### C Keeps



Lubricate keeps by applying industrial Vaseline or other suitable grease on the contact areas or leading edges (marked in red above).

### D Rollers



To help the smooth running action of the locking mechanism, apply a small amount of oil to each side of the rollers.

# Lubrication

## Door lubrication

### Door locks and keeps

For hinged doors, apply industrial Vaseline or other suitable grease to the hook and latch and striker surfaces (shown below). The lock gearbox has grease applied when it is made, which is designed to lubricate the lock for its life span.

**✘** Please do not add oil to the gearbox as this will dissolve the grease and reduce the life span of the lock.

You should keep lock and keep surfaces that you can see clean from dust and dirt by wiping with a clean, damp cloth.



Hook and latch.



Striker surfaces.

## Hinges



PVCu and composite door hinges are made with self-lubricating material and do not need oiling.

## Cylinders



For lubricating the lock cylinder, see page 38. Using a Phillips screwdriver, tighten the cylinder screw, which is on the faceplate of the lock.

## Sliding patio door pins



Apply a 3-in-1® oil to the mushroom pins and anti-slam pin.

# Adjustments

## Window adjustments

### Outward-opening casement windows

If the window does not stay in the position that it has been opened to or if it is stiff to move, you can increase or reduce the friction so it will stay put.



You can do this by turning the adjuster screw on the hinge (above) clockwise to increase the friction or anticlockwise to reduce the friction.

### Tilt and turn windows

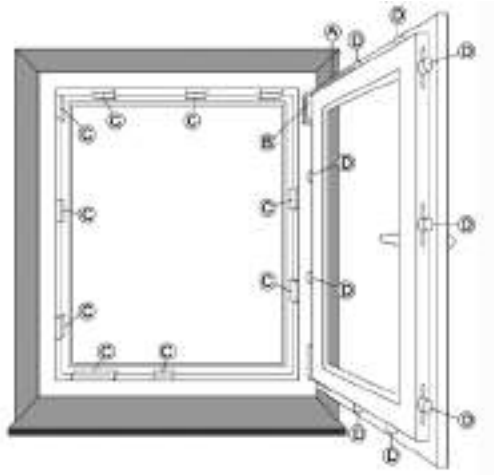

If there is a draught around your tilt and turn window, you can adjust the seal pressure around the frame and sash.

You can regulate this manually by adjusting the rollers labelled D (above).

There are two types of rollers to adjust. These can both be adjusted by 0.8mm either way.



To adjust with an Allen key - turn the roller using a 4mm Allen key.



### Door adjustment

The installers will have set up the door to work correctly. We do not recommend any further adjustment.

Hand adjusted – lift the roller with your hand and then turn it.

Both the Allen-key adjusted and hand-adjusted rollers have a line on the roller to show the amount of adjustment.

When the line is pointing directly outwards, the window is at minimum compression and when it is pointing directly inwards it is at maximum compression.

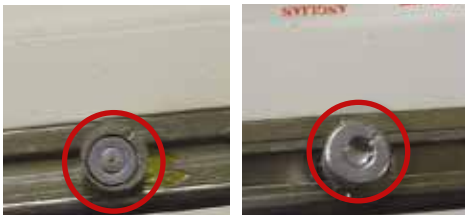

When the window is adjusted, these should all point in the same direction.

# Condensation

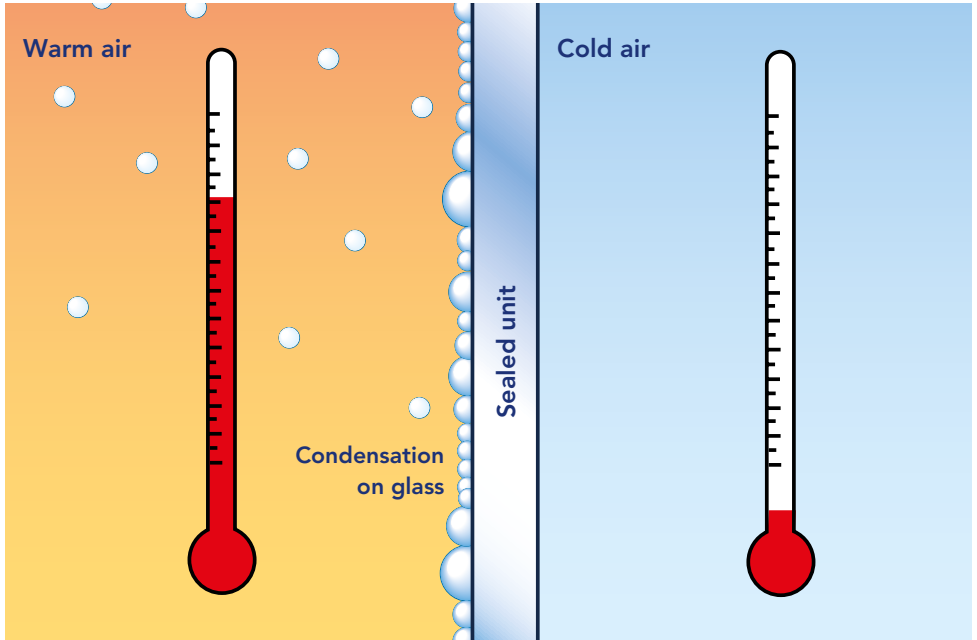

## What is condensation?

Condensation is the moisture caused by everyday living and happens when warm moist air comes into contact with cooler air or a cold surface.

Colder outside temperatures during winter months combined with heating inside the home can result in large amounts of condensation.

## Condensation and windows and doors

There are three areas of our windows and doors where condensation may normally form.

- The surface of the sealed unit which faces into the building.
- The surface of the sealed unit which faces outside the building.
- The surfaces within the sealed units. (If condensation appears here, there is a fault with the window or door.)

For more information, please see the Glass and Glazing Federation booklet: *Condensation some causes, some advice.*

Download a copy from our Residents Zone on our website:  
[www.anglian-building.co.uk](http://www.anglian-building.co.uk)



### Condensation on the surface inside the building

Condensation may form depending on the inside and outside temperatures. It can be controlled by making sure there is enough ventilation. It is not a fault in the product.

There are several things you can do to limit condensation. Drying clothes outdoors when possible can help. Certain types of heaters such as paraffin heaters can create lots of water vapour so you should avoid these.

Another way to reduce condensation is to close doors when cooking or showering. This means moisture is kept in a few rooms instead of spreading to the whole house. Make sure these rooms are suitably ventilated by keeping a small window open or turning on an extractor fan, to limit condensation.

### Condensation on the surface outside the building

This is nothing to worry about and shows the excellent insulation properties of the sealed units.

This form of condensation is common and not a problem with the unit.



### Condensation inside the sealed unit

This is between the two panes of the sealed unit and, unlike the two other examples of condensation above, it cannot be wiped off with a cloth.

This happens because water manages to penetrate the seal. As this condensation is within the sealed unit it cannot be removed.

If the unit is still under warranty, contact us to arrange an inspection.

# Troubleshooting

If there is a problem with your windows or doors, please read through this troubleshooting guide before calling for assistance. There may be a quick and easy fix to the problem.

If there is anything you are not sure about, please contact the Anglian Service Desk on 0800 542 3931 for advice or to book for an engineer to visit. (There may be a charge for an engineer to visit.)



## There is a draught around the window or door

Air movement detected near to a window or door may be due to natural currents caused by heating or cooling of the air (known as convection) and is not necessarily due to air leaking in through the window or door. In certain weather conditions, a small amount of air coming through the seals is acceptable.

If you are experiencing a draught around the window, you can check to see that the two rows of seals around the frame have not been dislodged. You can push these lightly back into place.

Trickle vents (where fitted) are not designed to be air tight when closed.

You can make adjustments to your tilt and turn window to change the seal pressure. Instructions for this are in the Adjustments section on page 30.

## Water visible in the frame

This is nothing to worry about, our windows are designed to drain away any water before it can leak into the property. There are drainage slots on the bottom of the frame that allow the water to drain out between the window and sill.

If there is any water entering your property, make sure the drainage slots and gaps between the frame and sill are clear of any debris. Please see page 18 for information on how to check the drainage slots. You also need to check to make sure the seals have not been dislodged from the frame.

# Troubleshooting

## Outward-opening casement windows



**Caution.** Take care to avoid any risk of falling from an open window.

### Problems closing the window

Is the window almost closed?

- Check there is nothing in the frame preventing the window from closing.
- Make sure the handle is in the fully opened position before closing and locking the window.

### Problems opening the window

- Check that the window is not locked with the key.
- Make sure there is no obstruction outside preventing the window from opening.

Do the windows have a restricted hinge?

These are designed to only open to about 10° to prevent accidents. To open the window fully, press the button on the slider (circled right) to disengage the restrictor.



Do this on both sides of a top-hinged window and just the bottom one on a side-hinged window.

### The window is stiff to move

Have the windows been lubricated, as described on page 25?

If they have been regularly maintained, the resistance on the hinge of the window can be reduced, making it easier to operate the window. See casement adjustment on page 30 for details.

### The window will not stay in the position it is opened to

It is possible that the adjuster screw on the hinge is too loose.

You can tighten this with a flat-head screw driver to increase the resistance between the slider and the hinge track. See window adjustment on page 30 for details.

# Troubleshooting

## The handle is loose

Over many years of use, the handle fixings may become loose. You can tighten them as shown below.

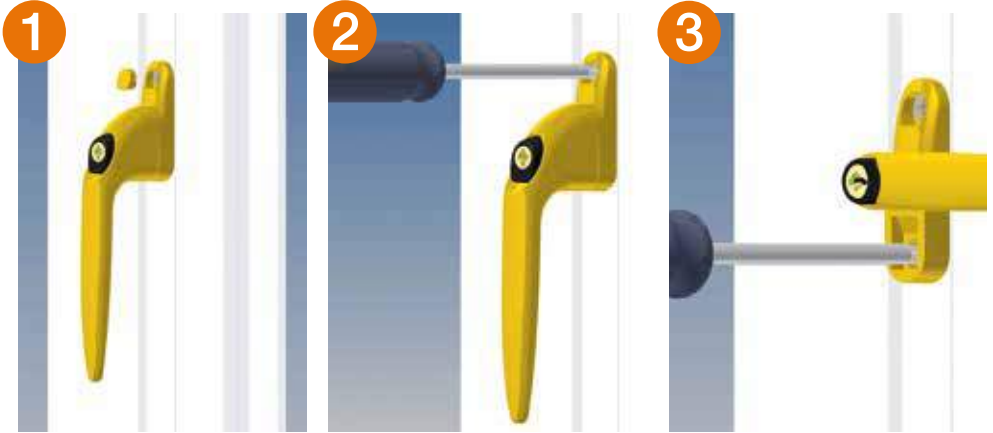

1 Carefully remove the top cover cap.

2 Tighten the top screw using a Phillips screwdriver and push the cover cap back into place.

3 Move the handle to the open position and tighten the bottom fixing.

## Tilt and turn windows

### Problems closing the window

Is the window almost closed?

- Check there is nothing in the frame preventing the window from closing.
- Make sure the handle is in the fully opened position before closing and locking the window.

### Problems opening the window

- Check that the window is not locked.
- Make sure there is no obstruction inside preventing the window from opening.

### The handle is stiff to move

Have you lubricated the locking mechanism?

Follow the instructions on how to lubricate rollers and keeps in the section on lubrication on page 27. You can adjust the rollers to reduce the compression - see tilt and turn seal pressure on page 30.

### The window is pivoting on only one corner

Under certain operations the tilt and turn window can go into both tilt and turn operation at the same time. Although the window is not designed to operate like this, it is perfectly safe and easy to return to a normal operating condition (shown below).

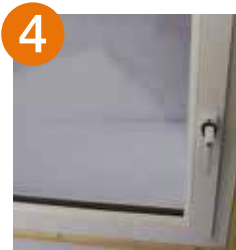
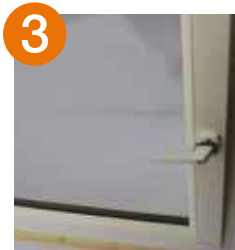
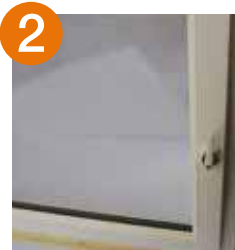

**1** Make sure the handle is positioned as shown. Push the bottom corner of the sash on the handle side back into place in the frame.

**3** Turn the handle to horizontal.

**4** Close the window and turn the handle to the closed position.

# Troubleshooting

## Doors

### Problems closing the door

Is the door almost closed?

- Check there is nothing in the frame preventing the door from closing.
- Make sure the handle is in the fully opened position before closing the door

Is the door failing to stay closed?

Open the door to check the locking gear operates when the handle is operated. To do this, move the handle to see if the hooks move. If they do not, lubrication could help this, see page 28.

Make sure that the white button (snib) is pushed downwards (where fitted).

### Problems opening the door

- Check that the door is not locked.

### The lock cylinder is stiff to operate

Lubricate the cylinder with lock graphite (or graphite pencil).

Apply this lubricant to the key only and work the key in and out of cylinder a few times. Never apply lubricant directly into the cylinder as this may cause the internal pins to stick. Do not use WD40® or other oils.

### Quality of sealed glass units

Due to the nature of the glass-production process, perfect quality and surfaces free of any marks cannot be guaranteed. Some blemishes are to be expected.

You need to check the sealed units for scratches on the outer faces of the panes as soon as reasonably possible after they are installed.

You can find more information in the Glazing Federation document 'Visual Quality of Double Glazing'. You can see this in the Residents Zone of [www.anglian-building.co.uk](http://www.anglian-building.co.uk).

0800 542 3931  
abpservicedesk@angliangroup.com  
www.anglian-building.co.uk



Unit 30, 59 Hurricane Way,  
Norwich, Norfolk NR6 6JB

Anglian Building Products policy is one of continued development and in accordance with this, we reserve the right to amend specification of our products as their development dictates.